



# AVAC18

## Operator's Manual



## CONTENTS

SYMBOLS USED IN THE MANUAL .....	3
PURPOSE AND CONTENT OF THE MANUAL .....	3
TARGET GROUP .....	3
STORING THE USE AND MAINTENANCE MANUAL .....	3
ON DELIVERY OF THE APPLIANCE .....	3
INTRODUCTORY COMMENT .....	3
IDENTIFICATION DATA .....	3
TECHNICAL DESCRIPTION .....	4
INTENDED USE .....	4
SAFETY .....	4
SERIAL NUMBER PLATE .....	4
TECHNICAL DATA .....	4
GENERAL SAFETY REGULATIONS .....	5
WIRING DIAGRAM .....	10
PREPARATION OF THE APPLIANCE .....	11
HANDLING THE PACKED APPLIANCE .....	11
HOW TO UNPACK THE APPLIANCE .....	11
HOW TO TRANSPORT THE APPLIANCE .....	11
LOCATION OF THE MAIN COMPONENTS OF THE APPLIANCE .....	11
LOCATION OF THE COMPONENTS OF THE COLLECTION TANK COVER UNIT ....	11
LOCATION OF THE COMPONENTS OF FILTER GROUP .....	11
LOCATION OF THE COMPONENTS OF THE COLLECTION TANK UNIT .....	12
APPLIANCE SAFETY .....	12
PREPARING TO WORK .....	12
WORK .....	13
AT THE END OF THE WORK .....	13
MAINTENANCE .....	14
RECOMMENDED MAINTENANCE OPERATIONS .....	14
CONTROLLING AND CLEANING THE COLLECTION BAG .....	14
CONTROLLING AND CLEANING THE COLLECTION TANK .....	14
CONTROLLING AND CLEANING THE VACUUM ACCESSORIES UNIT .....	15
CONTROLLING AND CLEANING THE FABRIC FILTER .....	15
DISPOSAL .....	15
CONTROL AND OPERATION .....	16
MOTOR FILTER CLEANING .....	17
MOTOR FILTER CLEANING .....	17
PARTS MANUAL .....	18
MAIN ASSEMBLY .....	19
COVER ASSEMBLY .....	20
FILTER .....	21
TANK ASSEMBLY .....	22
VACUUM MOTOR ASSEMBLY .....	24
LIMITED WARRANTY .....	26

The descriptions contained in this document are not binding. The company therefore reserves the right to make any modifications at any time to elements, details, or accessory supply, as considered necessary for reasons of improvement or manufacturing/commercial requirements. The reproduction, even partial, of the text and drawings contained in this document is prohibited by law.

**The company reserves the right to make any technical and/or supply modifications. The images are shown as a reference only, and are not binding as to the actual design and/or equipment.**

## SYMBOLS USED IN THE MANUAL



**Open book symbol with an "i":**  
Indicates the need to consult the instruction manual.



**Open book symbol:**  
Tells the operator to read the manual before using the appliance.



**Covered place symbol:**  
the operations preceded by this symbol must always be carried out in a dry, covered area.



**Warning symbol:**  
Carefully read the sections marked with this symbol and observe the indications, for the safety of the operator and the appliance.



**Disposal symbol:**  
carefully read the sections marked with this symbol for disposing of the appliance.



**Protective gloves symbol:**  
Always wear protective gloves, to avoid the risk of serious injury to your hands caused by sharp objects.



**Protective gloves symbol:**  
Always wear protective gloves, to avoid the risk of serious injury to your hands caused by chemical agents.



**Information symbol:**  
Indicates additional information for the operator, to improve the use of the device.

## PURPOSE AND CONTENT OF THE MANUAL

The aim of this manual is to provide customers with all the information needed to use the appliance in the safest, most appropriate and most autonomous way. It includes information concerning technical aspects, safety, operation, appliance downtime, maintenance, spare parts and scrapping. Operators and qualified technicians must read the instructions in this manual carefully before carrying out any operation on the appliance. If in doubt about the correct interpretation of instructions, contact your nearest Customer Service Center to obtain the necessary clarifications.

## TARGET GROUP

This manual is aimed at operators and qualified technicians responsible for appliance maintenance. Operators must not perform operations that should be carried out by qualified technicians. American Sanders cannot be held liable for damages resulting from failure to comply with this prohibition.

## STORING THE USE AND MAINTENANCE MANUAL

The Use and Maintenance Manual must be stored in its special pouch close to the appliance, protected from liquids and anything else that could compromise its legibility.

## ON DELIVERY OF THE APPLIANCE

When the machine is delivered to the customer, an immediate check must be performed to ensure all the material mentioned in the shipping documents has been received, in addition to verifying that the equipment has not been damaged during transportation. If this is the case, the carrier must ascertain the extent of the damage at once, informing our customer service office. It is only by prompt action of this type that the missing material can be obtained, and compensation for damage successfully claimed.

## INTRODUCTORY COMMENT

Any type of equipment can only work properly and effectively if used correctly and kept in full working order by performing the maintenance operations described in the attached documentation. You should therefore read this instruction manual carefully, consulting it again if issues arise while using the machine. If necessary, remember that our assistance service (organised in collaboration with our dealers) is always available for advice or direct intervention.

## IDENTIFICATION DATA

For technical assistance or to request replacement parts, always give the model, the version and serial number written on the serial number plate.

## TECHNICAL DESCRIPTION

The **AVAC 18** is a vacuum cleaner which uses the vacuum created inside the collection tank by the fan (enabled by the electric motor) to pick up dust and dry solid elements at ambient temperature, using the accessories in contact with the floor and the furnishings. The vacuum hose conveys inside the collection tank the air with dust and solid residues that are retained and collected using the collection bag and the filter. **The appliance must only be used for this purpose.**

## INTENDED USE

*This appliance is designed and built to be used by a qualified operator to clean (by vacuuming solid, dry elements) smooth, compact flooring in the commercial, residential and industrial sectors, in proven safety conditions.*

 *The appliance is only suitable for use in indoor - or at least covered - areas. The appliance is not suitable for use in the rain, or under jets of water. IT IS FORBIDDEN to use the appliance for picking up dangerous dusts or inflammable liquids in places with an explosive atmosphere. In addition, it is not suitable as a means of transport for people or objects.*

## SAFETY

Operator cooperation is paramount for accident prevention. No accident prevention program can be effective without the full cooperation of the operator who is directly responsible for machine operation. The majority of occupational accidents that happen both in the workplace or whilst moving are caused by failure to respect the most basic safety rules. An attentive, careful operator is most effective guarantee against accidents and is fundamental in order to implement any prevention program.

## SERIAL NUMBER PLATE

The serial number plate is located at the rear of the vacuum cleaner, and indicates the general characteristics of the appliance, in particular the appliance's serial number. The serial number is a very important piece of information and should always be provided together with any request for assistance or to purchase spare parts.

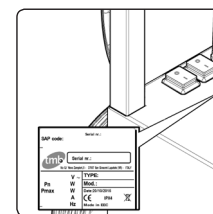

TECHNICAL DATA	U/M	AVAC 18
Technical characteristics of the motor (voltage - frequency)	V Hz	120 60
Total power (nominal)	W	1400
Vacuum motor	Nr. / (V / W / Hz)	2/(120/700/60)
Type of vacuum cleaner		Dry
Maximum vacuum	KPa inH <sub>2</sub> O	19 74
Maximum air flow rate	CFM CMM	175 4,95
Collection tank useful capacity	Gal L	18 68
Filtering capacity	in <sup>2</sup> cm <sup>2</sup>	3666 23651
Collection tank and vacuum chamber material		Painted Steel
Length of power supply cable	Ft m	50 15
Dry weight	Lbs Kg	92,6 42,5
Dimensions (length x width x height)	in cm	21,3 x 26,8 x 40,1 54 x 68 x 102
Hose diameter	in mm	2 50
Tube length	in mm	7,5 24,6
Protection rating	IP	X4
Sound level (ISO 11201)	dB (A)	80



## IMPORTANT SAFETY INSTRUCTIONS



*When using an electrical appliance, basic precautions should always be followed, including the following:*

### **READ ALL INSTRUCTIONS BEFORE USING THIS APPLIANCE**



**WARNING:** - To reduce the risk of fire, electric shock, or injury:

- A. Do not leave appliance when plugged in. Unplug from outlet when not in use and before servicing.
- B. Do not use outdoors or on wet surfaces.
- C. Do not allow to be used as a toy. Close attention is necessary when used by or near children.
- D. Use only as described in this manual. Use only manufacturer's recommended attachments.
- E. Do not use with damaged cord or plug. If appliance is not working as it should, has been dropped, damaged, left outdoors, or dropped into water, return it to a service center.
- F. Do not pull or carry by cord, use cord as a handle, close a door on cord, or pull cord around sharp edges or corners. Do not run appliance over cord. Keep cord away from heated surfaces.
- G. Do not unplug by pulling on cord. To unplug, grasp the plug, not the cord.
- H. Do not handle plug or appliance with wet hands.
- I. Do not put any object into openings. Do not use with any opening blocked; keep free of dust, lint, hair, and anything that may reduce air flow.
- J. Keep hair, loose clothing, fingers, and all parts of body away from openings and moving parts.
- K. Turn off all controls before unplugging.
- L. Use extra care when cleaning on stairs.
- M. Do not use to pick up flammable or combustible liquids, such as gasoline, or use in areas where they may be present.
- N. Connect to a properly grounded outlet only. See Grounding Instructions.
- O. Do not pick up anything that is burning or smoking, such as cigarettes, matches, or hot ashes.
- P. Do not use without dust bag and/or filters in place.
- Q. Make sure your extension cord is in good condition.
- R. Use only the extension cord provided within the packaging of the appliance. Do not use other extension cord which could cause a drop in line voltage resulting in loss of power and overheating.
- S. Maintain Appliance With Care - Inspect extension cords periodically. If the extension cord is damaged immediately contact an authorized American Sander distributor.
- T. To reduce the risk of disconnection of the appliance cord from the extension cord during operating, secure the extension cord to the appliance plug as shown or described in the Operating Instructions.
- U. Maintain Appliance With Care - Inspect extension cords periodically and replace if damaged.

**SAVE THIS INSTRUCTION**

## **SAFETY WARNINGS FOR DRY VACUUM**

Before using the appliance for the first time, read and comply with these safety warnings. Keep these safety warnings for consultation in the future or to hand them over to successive owners. Before commissioning, read the appliance's user manual. The warning plates on the appliance provide important instructions for its safe use. Always comply with both the directions on the instructions, as well as current safety standards. Keep the packing film out of the reach of children.  
Risk of asphyxiation!

### **CONNECTION TO THE ELECTRICITY GRID**

**DANGER:** 

- To reduce the risk of fire, electric shocks or injury, please read and follow the safety instructions and warning indications before using. This vacuum cleaner has been designed to be safe when it is used for cleaning in the specified manner. If damage to electrical or mechanical components is found, the vacuum cleaner and/or the accessory must be repaired at the relative authorized service center or else at the manufacturer before use, in order to prevent further damage to the appliance or physical injury to the user.
- Before connecting the appliance to the electricity socket, make sure the electrical information on the plate corresponds to that of the electrical supply. The appliance must only be powered with alternating current and voltage equal to that shown on the serial number plate.
- The power supply cable outlet must have an earth connection in compliance with the regulatory standards.
- The cable for connecting to the electrical that is supplied with the appliance should be used for the above-mentioned appliance and not for other appliances.
- Before using, check for any damage on the connection cable and on the power plug. If the cable is damaged, immediately contact a technician for restoring normal functioning.
- Never touch the power plug with wet hands.
- Make sure that the cable to the electrical or the extension cable have not been damaged by having been walked on, crushed, pulled or the like. Protect the cable from heat and from contact with oils or sharp edges.
- Regularly check that the cable connecting to the electrical is not damaged, for example with signs of ageing or cracks. If damage is found, the cable should be replaced before using the appliance again.
- Protection against splashes of water and the mechanical strength need to be ensured also after any replacement of the joints of the power cable or the extension cable.
- Do not clean the appliance with a hose or a jet of high pressure water (risk of short-circuit or other electrical faults).

**ATTENTION:**

- The procedure causes short-term reduction in voltage.
- In unfavourable grid conditions the other appliances could be damaged.
- This damage could occur if the grid impedance is less than  $0.15\Omega$ .

## USE - EMPLOYMENT

- Do not use the machine in ways other than those indicated, otherwise the company is not responsible for any damage to things and people or to the failure of the vacuum cleaner. Use of accessories not recommended by the device manufacturer may result in unsafe conditions.
- Never use with a damaged cable or plug. When removing from an electrical socket, pull the plug and not the cable. Do not handle the plug or the vacuum cleaner with wet hands. Deactivate all the controls before connecting or disconnecting from the electrical socket
- Do not pull or transport the appliance by the cable, do not use the cable as a handle, do not close a door on the cable, and do not pull the cable around edges or sharp corners. Do not pass the vacuum cleaner over the cable. Keep the cable away from hot surfaces.
- Be careful when cleaning on stairs.
- The appliance must not be used or kept outdoors, in damp conditions or directly exposed to rain.
- The storage temperature must be between -13°F and +131°F.
- Conditions of use: ambient temperature between 32°F and 104°F with a relative humidity between 30 and 95%. The vacuum cleaner has been developed only for dry cleaning and it should not be used or kept outdoors in moist conditions.
- Before using, make sure the appliance and the work equipment and in particular the extension cable are in a good condition. If there is any damage, immediately pull out the power plug from the electrical socket. The appliance should not be used.
- When the appliance is used in dangerous situations (for example filling stations) the relative safety regulations must be followed. It is forbidden to use the appliance in areas with a high risk of explosion.
- Certain substances can form explosive vapours and mixtures together with intake air.
- Never vacuum the following substances:
  - Explosive or inflammable gases, liquids and powders (reactive powders).
  - Reactive metal powders (for example aluminium, magnesium, zinc) together with strongly alkaline detergents and acids.
  - Acids and alkalines in their purest state.
  - Organic solutions (for example gasoline, paint thinners, acetone or gasoline).
- Keep hair, loose clothing, fingers and all body parts away from openings and from moving parts. Do not put objects into the openings or use the appliance with the opening blocked. Keep the openings free of dust, fur, cloths, hair, and everything else that can reduce the air flow.
- This appliance is not suitable for vacuuming dangerous powders.
- Do not use to vacuum flammable or combustible liquids like gasoline, or use in areas where they may be present.
- Do not vacuum anything that is burning or smouldering, like cigarettes, matches or glowing embers.
- Use of the appliance is permitted for children over 8 years of age and people with reduced physical, sensorial and mental capacities or people with no experience or understanding as long as they are supervised or have received instructions regarding the safe use of the appliance and understand the related risks.
- Children must be supervised to make sure they do not play with the appliance.
- Children should not do any cleaning or maintenance that is the responsibility of the user without supervision.
- This appliance should only be used in closed areas.
- Never leave the appliance unattended when it is connected to the electrical socket. Take the plug out of the socket when not used and before any maintenance.
- It is forbidden to vacuum persons or animals with this appliance.
- In low temperatures, the appliances should not be used outdoors.

## CAUTION:

- When the appliance is operating do not bring it close to delicate organs like ears, mouth, eyes, etc.
- The device must only be kept in closed areas.
- If the vacuum cleaner is not working properly or it has fallen, been damaged, left outside or has fallen in water, take it to a service center or back to the retailer.
- Always use the appliance in compliance with its intended use, taking into consideration local conditions and looking out for the presence of others, especially children, when working.
- Never leave the appliance unattended until it has been switched off and the plug has been taken out of the electrical socket.
- Always wear suitable protective gloves when working with the appliance.
- The appliance should only be used by people trained in its use and who have shown that they know how to use the appliance and have been expressly authorized to do so.
- Do not place any liquid containers on the appliance.
- In the event of a fire, use a powder extinguisher. Do not use water.
- If foam forms or liquid leaks, immediately switch off the appliance.

## MAINTENANCE DANGER:

- Before cleaning and carrying out maintenance on the appliance and before replacing any components, switch off the appliance and pull out the power plug from the electrical socket.
- Repairs should only be carried out by authorized service centers or by personnel who are experts in this field and who are familiar with all the current safety norms.
- Observe the safety check as per local provisions for commercial appliances.

## ACCESSORIES AND SPARE PARTS

### CAUTION:

Only use accessories and spare parts that have been authorized by the manufacturer. Original accessories and spare parts ensure the appliance can be used safely and without any fault.





# WIRING DIAGRAM

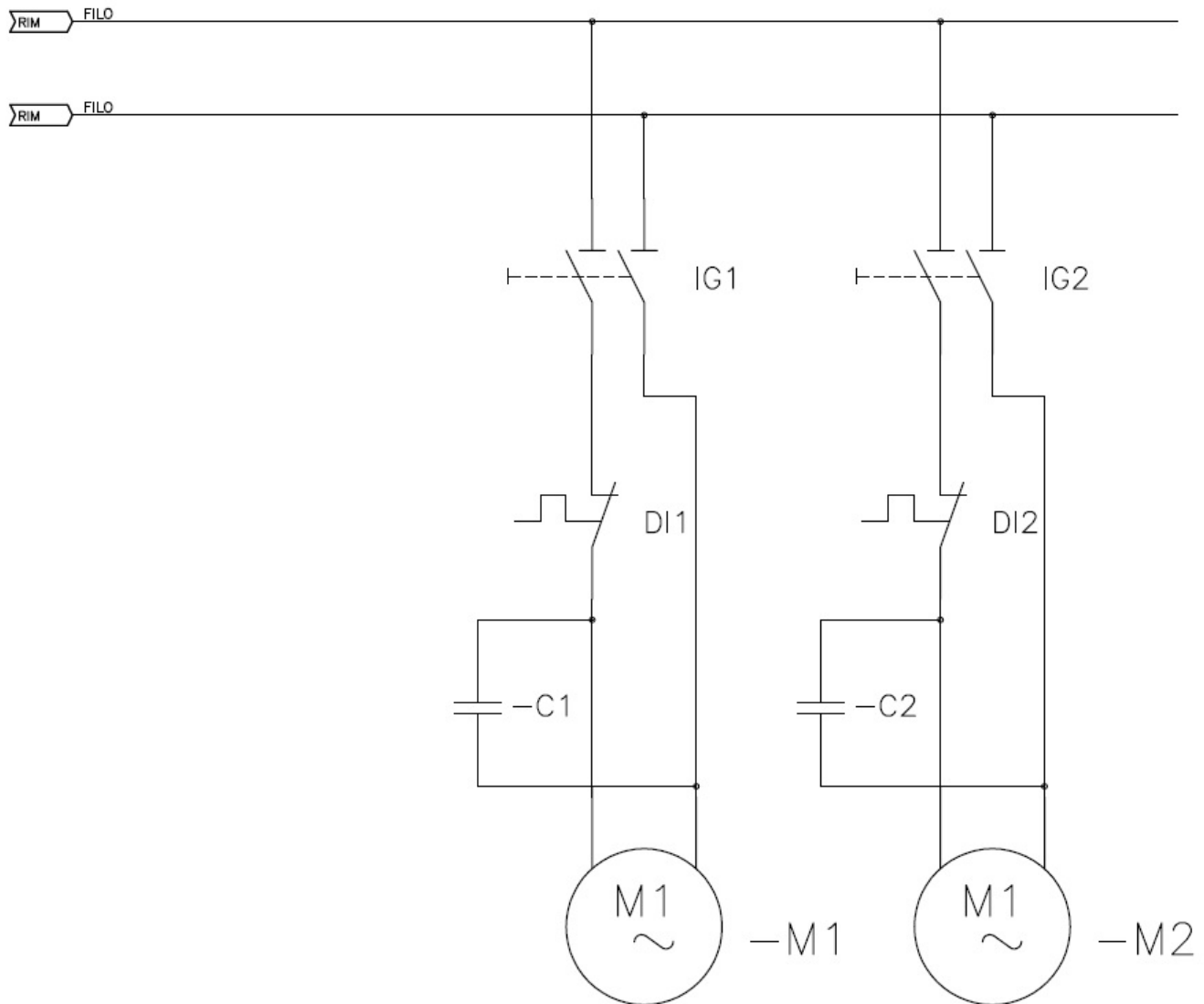

IG1-IG2 INTERRUTTORE BIPOLARE

TWO POLES SWITCH - INTERRUPTEUR BIPOLAIRE - INTERRUPTOR BIPOLAR - ZWEIPOLIGERSCHALTER

M1 - M2 MOTORI

MOTOR - MOTEUR - MOTOR

## PREPARATION OF THE APPLIANCE

### HANDLING THE PACKED APPLIANCE

Since the packaging elements (plastic bags, staples, etc.) are a potential source of danger, they should not be left within the reach of children, disabled persons, etc.

The gross weight of the appliance, including packaging, is 65 Kg.

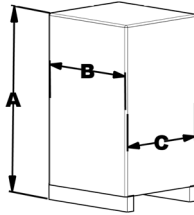

The dimensions of the package are as follows:

	U/M	
A	in	43,7
B	in	23,07
C	in	25,43



**ATTENTION:** Move the packaged product in accordance with legal legislation requirements regarding accident prevention, the size and the mass of the packaging itself.

### HOW TO UNPACK THE APPLIANCE

The procedure for removing the device from its packaging is the following:

1. Place the lower part of the outer packaging in contact with the floor.



**ATTENTION:** Use the pictograms printed on the box as reference.

2. Remove the outer package.



**ATTENTION:** these operations must be carried out using protective gloves to avoid any possible contact with the edges or tips of metal objects.

3. Using a chute, slide the machine from the pallet.

### HOW TO TRANSPORT THE APPLIANCE

To transport the machine, proceed as follows:

1. Take all necessary steps to ensure that the device is in a safe condition (see [MACHINE SAFETY](#)”).



**ATTENTION:** Users are advised to always wear protective gloves, to avoid the risk of serious injury to hands.



**ATTENTION:** for transportation without a pallet, secure the device according to the directives in force in the country of use so that it does not slide or tip over.

2. Make sure that the collection tank is empty, otherwise empty it (read the paragraph [“CHECKING AND CLEANING THE COLLECTION BAG”](#)”).

### LOCATION OF THE MAIN COMPONENTS OF THE APPLIANCE

The basic components of the appliance are as follows:

1. Collection tank unit.
2. Collection tank lid unit.
3. Filter - collection bag unit.
4. Engine Cooling air filter

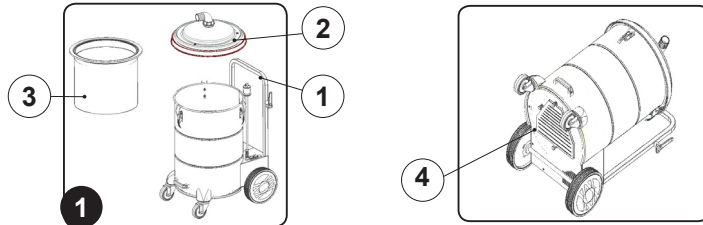

### LOCATION OF THE COMPONENTS OF THE COLLECTION TANK COVER UNIT

The components of the collection tank cover are as follows:

1. Collection tank lid.
2. Vacuum nozzle.

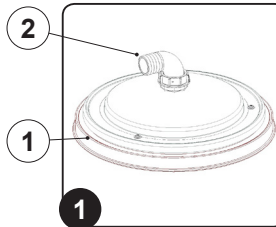

### LOCALIZING FILTER GROUP COMPONENTS

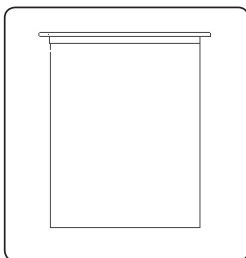

3.A

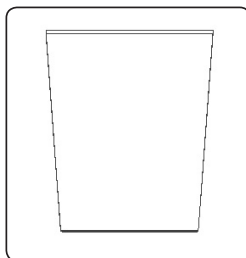

3.B

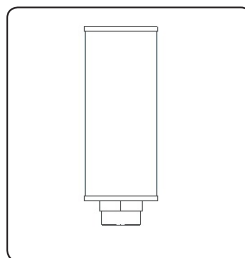

3.C

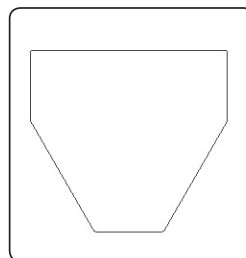

3.D

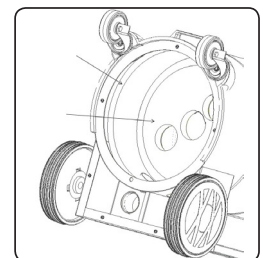

3.E

## LOCATION OF THE COMPONENTS OF THE COLLECTION TANK UNIT

The components of the collection tank are as follows:

1. Collection tank.
2. Front pivoting wheels.
3. Rear wheels.
4. Vacuum motor control switch.
5. Exhaust air noise reduction filter.
6. Control handlebar.
7. Collection tank lid coupling - uncoupling hinges.

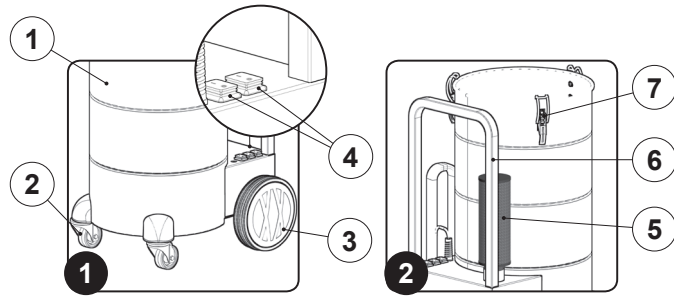

## APPLIANCE SAFETY

The stages for making the appliance safe, thereby making it possible to carry out operations safely, are as follows:

1. Make sure that the main switch (1) is in the rest position, if not, disable it by pushing the switch to "0" (Fig.1).
2. Make sure that the plug (2) on the power cable (3) has been taken out of the electrical supply socket (4), and if not, disconnect it (Fig.2).
3. Wind the cable around the control handlebar.

**ATTENTION:** Users are advised to always wear protective gloves, to avoid the risk of serious injury to hands.

**ATTENTION:** To prevent any damage to the electrical socket, pull out the plug (2) from the electrical socket (4) by pulling the plug (2) directly instead of the power cable (3).

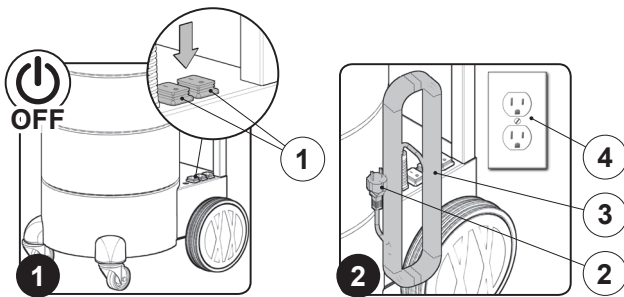

## PREPARING TO WORK

Before beginning to work, it is necessary to:

1. Before using, the appliance must be in order and safe to use with the work equipment, especially the power cable and the extension cable. If everything is not in order, the appliance must not be used.
2. Take all necessary steps to ensure that the device is in a safe condition (see [MACHINE SAFETY](#)™).

**ATTENTION:** Users are advised to always wear protective gloves, to avoid the risk of serious injury to hands.

3. Free the cover from the collection tank by releasing its hooks (1) on the side of the collection tank (Fig. 1).
4. Remove the cover (2) from the collection tank (Fig.2).
5. Put the cover delicately on the floor.
6. Check that the fabric vacuum filter (3) is inside the tank, if not put it in (Fig.3).
7. Insert the collection bag (4) inside the collection tank (Fig.4), being careful to position it correctly inside the filter.

**ATTENTION:** To fix the collection bag fold the hem around the inlet mouth of the collection tank.

8. Put the cover (2) on the collection tank (Fig.5).

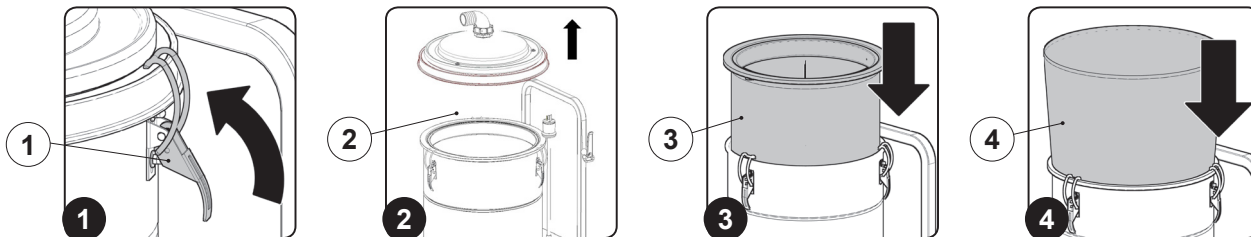

9. Fix the cover to the collection tank by using its hooks (1) on the side of the collection tank (Fig. 6).

10. Insert the vacuum hose (6) into the vacuum nozzle (7) in the cover (Fig.7).
11. Select the most suitable accessory for the work to be carried out.
12. Insert the selected accessory into the vacuum hose.

**ATTENTION:** The collection bag-filter should only be used for collecting solid waste.

**ATTENTION:** Never use the appliance without the filters supplied with the machine.

**ATTENTION:** When using the collection bag, do not vacuum waste that could cut it, burning embers that could set it on fire, or acid solutions that could dissolve it.

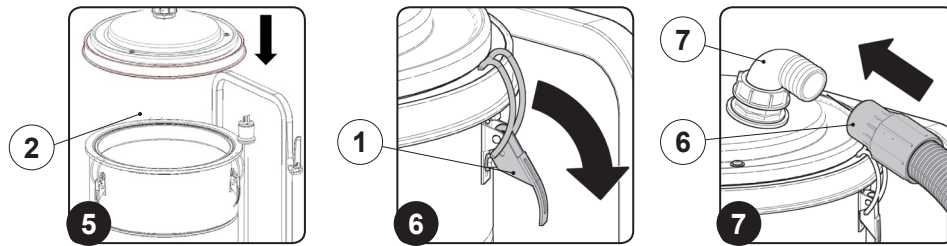

## WORK

To start working, do as follows:

1. Carry out all the checks in the section "[PREPARING TO WORK](#)".
2. Insert the plug (1) of the power supply cable (2) in the electrical supply socket (3) (**Fig.1**).
3. Switch on the machine by positioning one of the two switches (4) to the work position "I" (**Fig. 2**).

ⓘ **ATTENTION:** to double the vacuum capacity progressively activate the other switch.

4. Proceed with the vacuuming.

ⓘ **ATTENTION:** "If, when working, the intensity of the vacuum should drop, read the chapter [CONTROL AND OPERATION](#)".

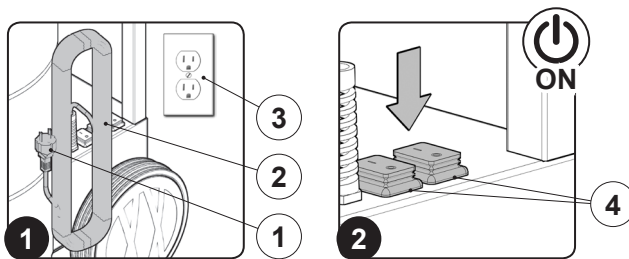

## AT THE END OF THE WORK

At the end of the work, and before carrying out any type of maintenance, perform the following operations:

1. Do what is required to make sure the machine is in a safe condition (see [MACHINE SAFETY](#)™).
2. Take the appliance to the designated place for emptying the collection tank.

ⓘ **ATTENTION:** the place designated for this operation must comply with current environmental protection regulations.

3. Empty the collection tank (see the section "[CHECKING AND CLEANING THE COLLECTION BAG](#)").
4. Remove the accessory from the extension, clean it with a damp cloth.

ⓘ **ATTENTION:** When it is completely dry insert it into the accessories support on the rear of the collection tank (optional accessory).

5. Remove the female part of the extension from the male part, clean it under running water.

ⓘ **ATTENTION:** When it is completely dry insert it into the accessories support on the rear of the collection tank (optional accessory).

6. Remove the vacuum hose (1) (**Fig.1**) from the vacuum nozzle (2) in the cover of the collection tank, clean it under running water.

ⓘ **ATTENTION:** When it is completely dry insert it into the accessories support on the rear of the collection tank (optional accessory).

🏠 **ATTENTION:** park the appliance in an enclosed place, on a flat surface; near the appliance there must be no objects that could either damage it, or be damaged through contact with it.

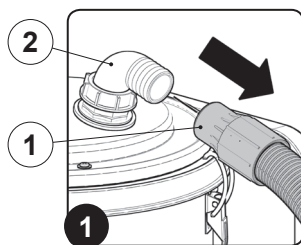

## MAINTENANCE

### RECOMMENDED MAINTENANCE OPERATIONS

TYPE OF MAINTENANCE	AT THE END OF THE WORK	DAILY	WEEKLY	BEFORE A LONG PERIOD OF INACTIVITY	TRANSPORT
Inspect and clean the collection bag (3.B)	X		X	X	X
Inspect and clean the collection tank (1)	X	X		X	X
Inspect and clean the vacuum accessories tools	X			X	
Inspect and clean the engine cooling air filter (3.D)	X				
Inspect and clean the exhaust filter (3.C)		X			
Inspect and clean the fabric filter CLASS M (3.A)		X		X	
Inspect and clean the sound absorbent (3.E)				X	

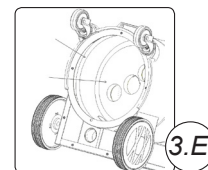
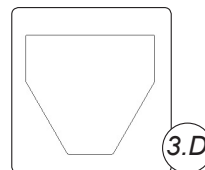
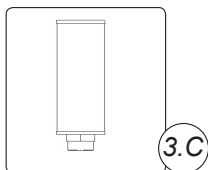
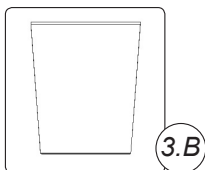
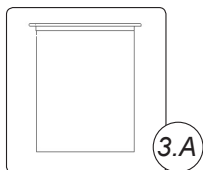

### CONTROLLING AND CLEANING THE COLLECTION BAG

To empty the collection bag, proceed as follows:

1. Take all necessary steps to ensure that the device is in a safe condition (see [MACHINE SAFETY](#)™).



**ATTENTION:** Users are advised to always wear protective gloves, to avoid the risk of serious injury to hands.

2. Free the cover from the collection tank by releasing its hooks (1) on the side of the collection tank ( Fig. 1).
3. Remove the cover (2) from the collection tank ( Fig.2).
4. Put the cover delicately on the floor.

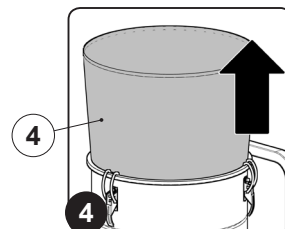
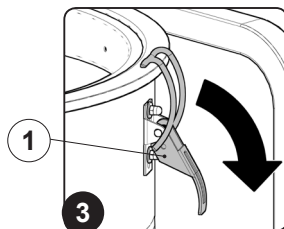
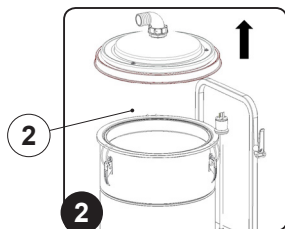
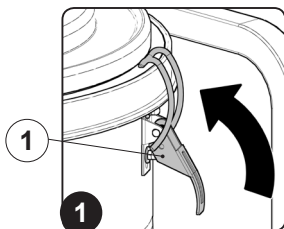

5. Fix the fabric filter to the collection tank by using its hooks (1) on the side of the collection tank ( Fig. 3).
6. Remove the collection bag (3) from inside the appliance ( Fig.4).
7. Take it to a suitable place and empty it.



**ATTENTION:** the place designated for this operation must comply with current environmental protection regulations.

8. Vacuum the bag with a vacuum cleaner.
9. Clean the collection bag with an air jet from a distance of more than 20cm.
10. To refit the collection bag carry out the operations in the reverse order.

### CONTROLLING AND CLEANING THE COLLECTION TANK

Properly cleaning the collection tank improves the appliance's efficiency. To clean the collection tank, proceed as follows:

1. Take all necessary steps to ensure that the device is in a safe condition (see [MACHINE SAFETY](#)™).



**ATTENTION:** Users are advised to always wear protective gloves, to avoid the risk of serious injury to hands.

2. Free the cover from the collection tank by releasing its hooks (1) on the side of the collection tank ( Fig. 1).
3. Remove the cover (2) from the collection tank ( Fig.2).

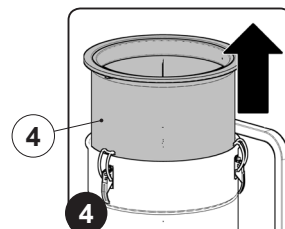
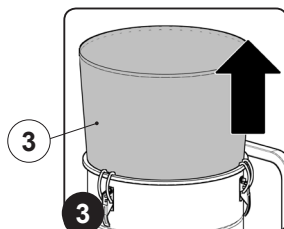
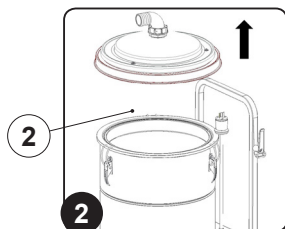
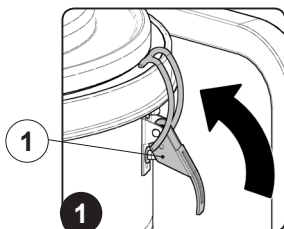

4. Put the cover delicately on the floor.
5. Remove the collection bag (3) from inside the appliance ( Fig.3).
6. Remove the fabric filter (4) from inside the appliance ( Fig.4).
7. Take it to a suitable place for cleaning.



**ATTENTION:** the place designated for this operation must comply with current environmental protection regulations.

8. Clean the inside of the collection tank with a cloth.
9. Clean the inside of the collection tank with a damp cloth.
10. To refit the fabric filter carry out the operations in the reverse order.

## CONTROLLING AND CLEANING THE VACUUM ACCESSORIES UNIT

Properly cleaning the vacuum accessories improves the appliance's efficiency. Proceed as follows to clean the vacuum accessories:

1. Do what is required to make sure the machine is in a safe condition (see [MACHINE SAFETY](#)™).
2. Take the appliance to the designated place for emptying the collection tank.

**(i) ATTENTION:** the place designated for this operation must comply with current environmental protection regulations.

3. Remove the accessory from the extension, clean it with a damp cloth.

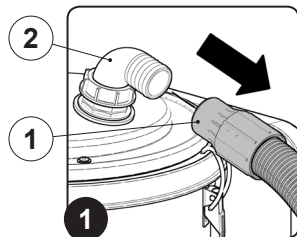

**(i) ATTENTION:** When it is completely dry insert it into the accessories support on the rear of the collection tank (optional accessory).

4. Remove the female part of the extension from the male part, clean it under running water.

**(i) ATTENTION:** When it is completely dry insert it into the accessories support on the rear of the collection tank (optional accessory).

5. Remove the vacuum hose (1) (**Fig.1**) from the vacuum nozzle (2) in the cover of the collection tank, clean it under running water.

**(i) ATTENTION:** When it is completely dry insert it into the accessories support on the rear of the collection tank (optional accessory).

## CONTROLLING AND CLEANING THE FABRIC FILTER

Properly cleaning the fabric filter improves the appliance's efficiency. To clean the fabric filter, proceed as follows:

1. Take all necessary steps to ensure that the device is in a safe condition (see [MACHINE SAFETY](#)™).

**(i) ATTENTION:** Users are advised to always wear protective gloves, to avoid the risk of serious injury to hands.

2. Free the cover from the collection tank by releasing its hooks (1) on the side of the collection tank (**Fig. 1**).
3. Remove the cover (2) from the collection tank (**Fig.2**).
4. Put the cover delicately on the floor.

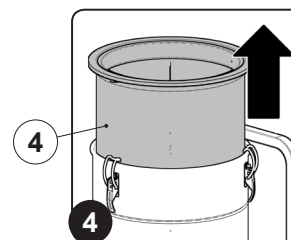
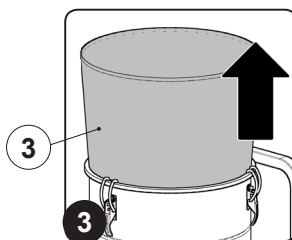
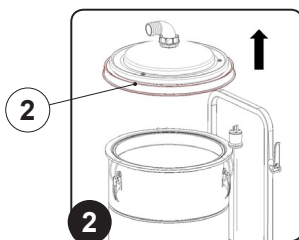
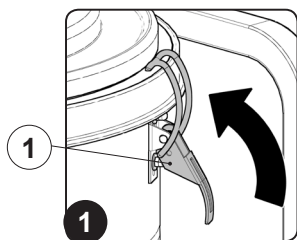

5. Remove the collection bag (3) from inside the appliance (**Fig.3**).
6. Remove the fabric filter (4) from inside the appliance (**Fig.4**).
7. Take it to a suitable place for cleaning.

**(i) ATTENTION:** the place designated for this operation must comply with current environmental protection regulations.

8. Vacuum the fabric filter with another vacuum cleaner.
9. Clean the fabric filter with an air jet from a distance of more than 20cm.
10. To refit the fabric filter carry out the operations in the reverse order.

## DISPOSAL

To dispose of the appliance, take it to a demolition center or an authorized collection center.

Before scrapping the appliance, it is necessary to remove and separate out the following materials, then send them to the appropriate collection centers in accordance with applicable environmental hygiene regulations:

- Electric and electronic parts\*
- Plastic parts
- Metallic parts

(\* In particular, contact your distributor when scrapping electric and electronic parts.

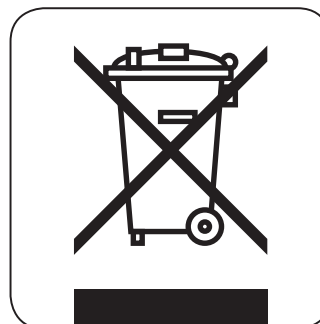

## CONTROL AND OPERATION

This chapter lists the most common problems linked with the use of the appliance. If you are unable to resolve the problems with the information given here, please contact your nearest assistance center.

PROBLEM	POSSIBLE CAUSE	SOLUTION
THE APPLIANCE DOES NOT SWITCH ON.	The main switch is in the rest position.	Place the main switch on "I".
	The power cable extension is not connected to the electrical socket.	Connect the power cable plug to the electrical socket.
	The appliance's electronic specifications do not match the electrical supply specifications.	Check that the technical information on the serial number plate correspond to the electrical supply information.
	The power cable is damaged.	If the power cable is damaged replace it, immediately contact an authorized American Sanders distributor.
DUST COMING OUT DURING VACUUMING.	The vacuum hose is not properly connected to the vacuum nozzle.	Connect the vacuum hose to the nozzle on the collection tank.
	The vacuum hose is not properly connected to the accessory in contact with the floor.	Connect the vacuum hose to the accessory that is being used to do the vacuuming.
	The collection tank cover has not been properly positioned.	Place the cover on top of the collection tank and secure it using the side hooks.
	The collection bag has not been positioned correctly.	Remove the collection tank cover and position the collection bag correctly.
	The collection bag is full or was torn.	Remove the cover of the collection tank and empty the collection bag or else change it (see the paragraph "CHECKING AND CLEANING THE COLLECTION BAG").
	The fabric filter is not correctly positioned.	Remove the collection tank cover, remove the collection bag and position the fabric filter correctly.
	The fabric filter is clogged or has torn.	Remove the collection tank cover, remove the collection bag and clean or replace the fabric filter (read the paragraph "CONTROLLING AND CLEANING THE FABRIC FILTER").
THE VACUUM CAPACITY IS INSUFFICIENT	The vacuum hose is blocked.	Check that there is nothing obstructing the vacuum hose, if there is, remove it.
	The vacuum chamber of the accessory in contact with the floor is blocked.	Check that there is nothing obstructing the vacuum chamber of the accessory being used, if there is, remove it.
	Dust coming out during vacuuming.	Read the paragraph "DUST COMING OUT DURING VACUUMING".
	The cap of the vacuum nozzle has not been closed properly.	Insert the cap into the vacuum nozzle correctly.



## IMPORTANT MOTOR FILTER CLEANING



1 Tilt the machine



2

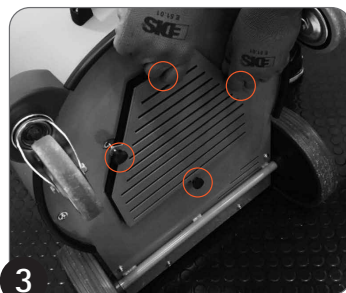

3 Unscrew the 4 knobs



4 Remove the protection



5 Clean the filter



a Shake the filter



b Vacuum the filter with the vacuum itself



c Blow the filter with an air gun

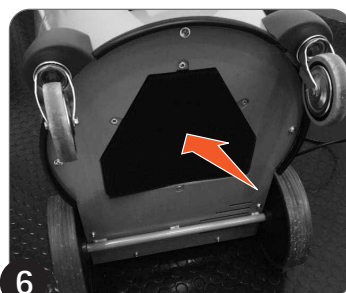

6 Place the filter inside the machine

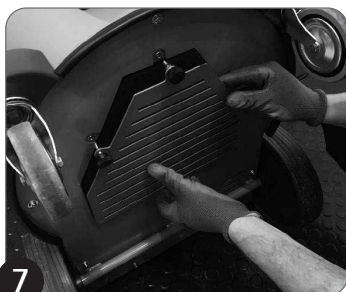

7 Place the protection

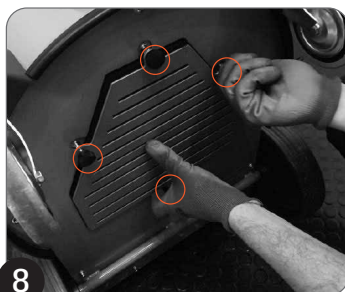

8 Screw the 4 knobs





# Main Assembly

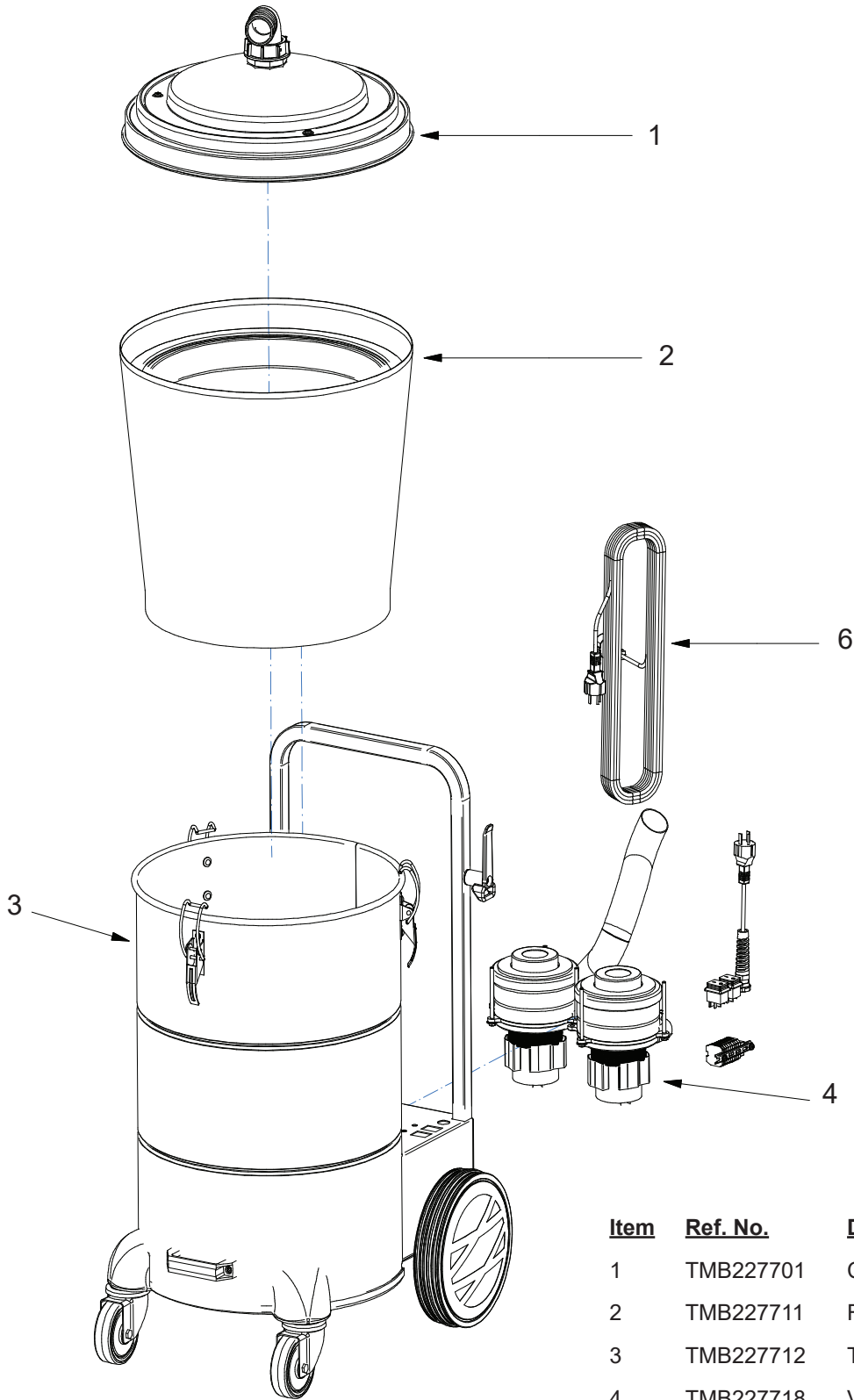

<u>Item</u>	<u>Ref. No.</u>	<u>Description</u>	<u>Qty</u>
1	TMB227701	COVER ASSEMBLY	1
2	TMB227711	FILTER	1
3	TMB227712	TANK ASSEMBLY	1
4	TMB227718	VACUUM	1
5	TMB227726	ACCESSORIES KIT	1
6	TMB447269	CABLE SJTW 3 x 14 AWG 105D GREY PLUG USA	1

## Cover Assembly

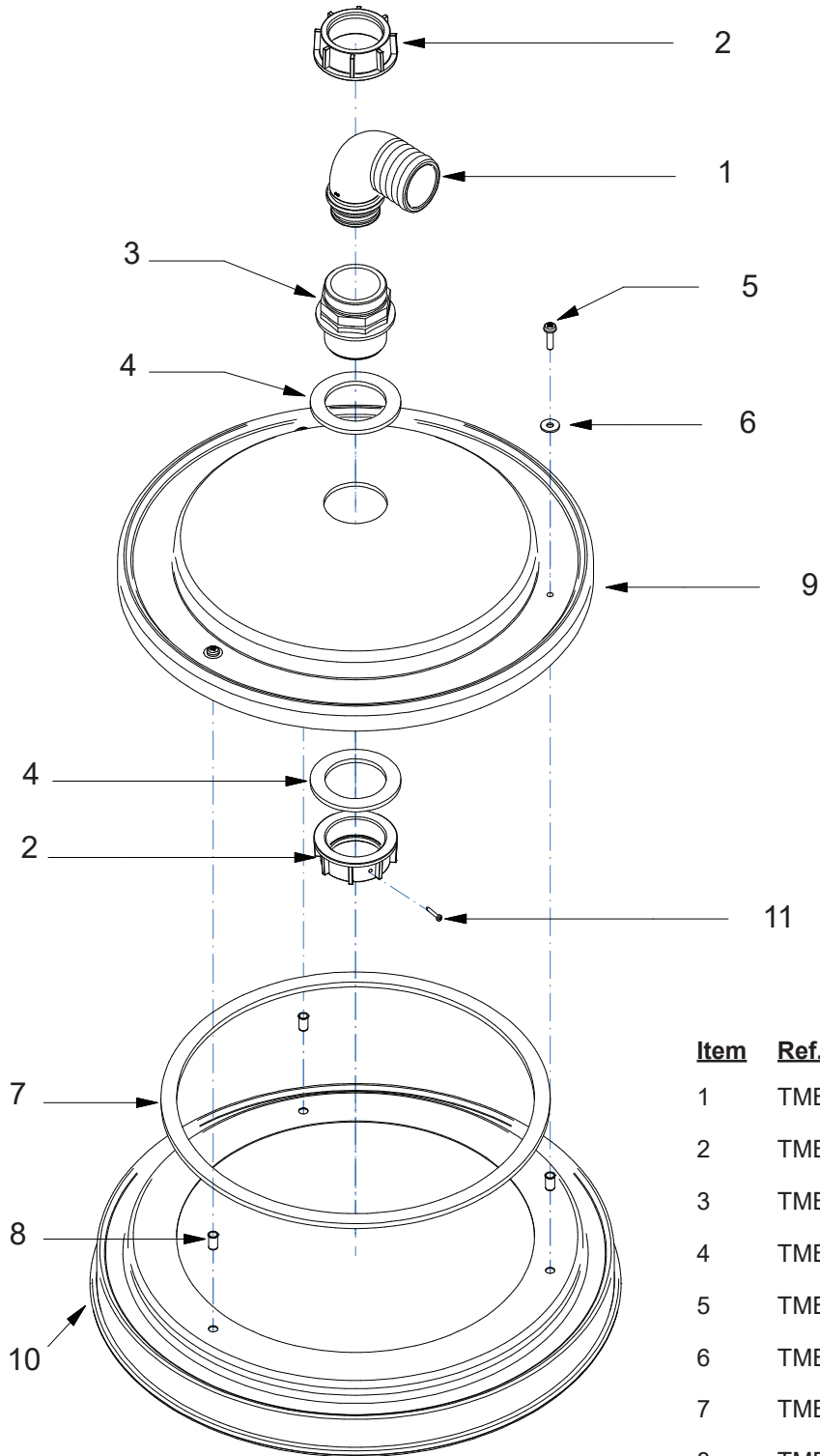

<u>Item</u>	<u>Ref. No.</u>	<u>Description</u>	<u>Qty</u>
1	TMB441694	ELBOW	1
2	TMB441695	FLY NUT	2
3	TMB224842	NIPPLE	1
4	TMB417555	GASKET	2
5	TMB408862	SCREW	3
6	TMB409160	WASHER	3
7	TMB417541	GASKET 15 x 15 x 700	1
8	TMB4105545	INSERT	3
9	TMB449937	POLYCARBONATE LID 1 INLET	1
10	TMB224404	COVER D .496 RAL 3002	1
11	TMB418269	SELF-TAPPING SCREW 2.9 X 19 TC T.C. ZNT	1

# Filter

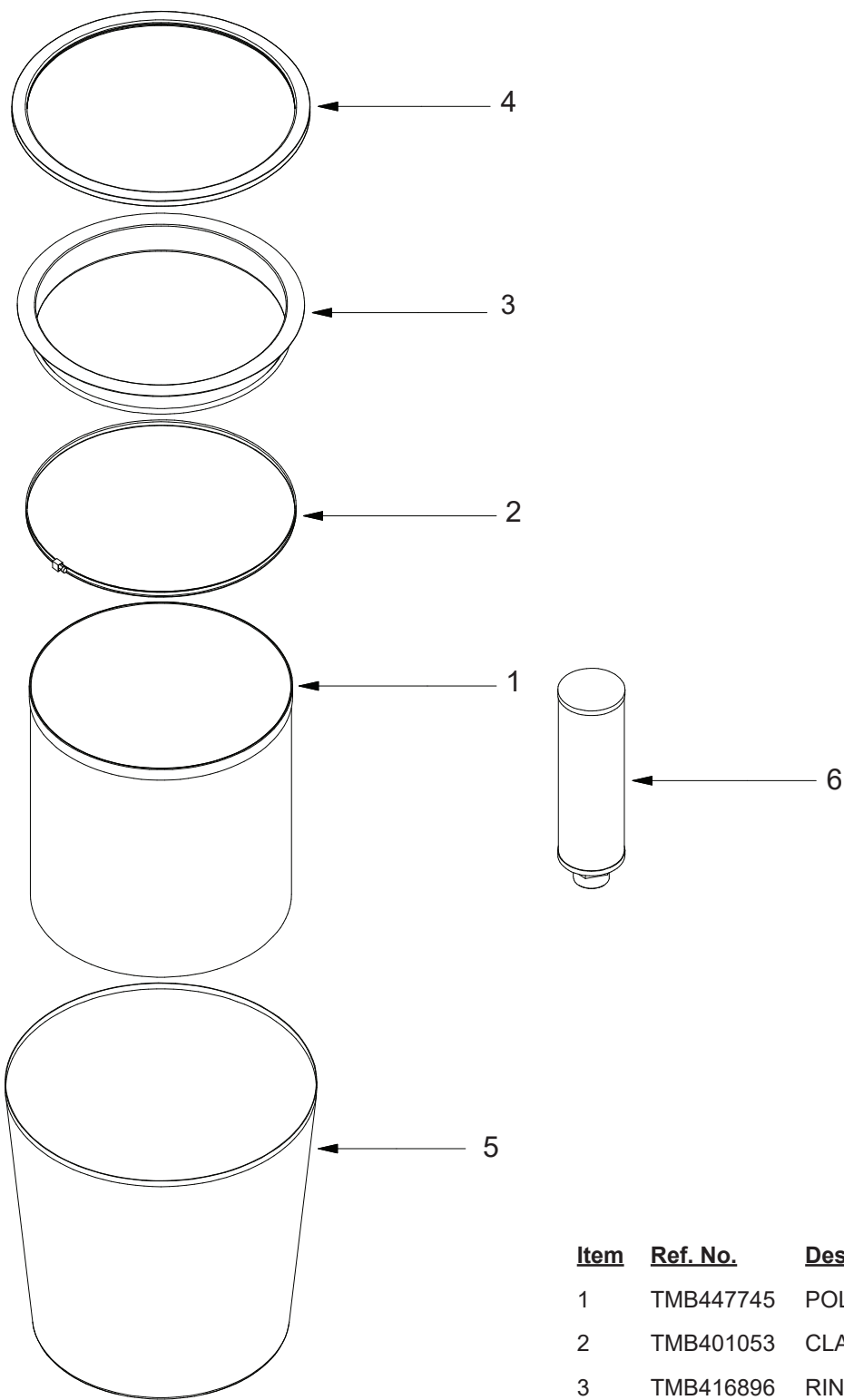

<u>Item</u>	<u>Ref. No.</u>	<u>Description</u>	<u>Qty</u>
1	TMB447745	POLYESTER FILTER CLASS M	1
2	TMB401053	CLAMP	1
3	TMB416896	RING	1
4	TMB401051	GASKET	1
5	TMB447746	FILTER TNT	1
6	TMB441751	FILTER H .000 CLASS L	1

# Tank Assembly

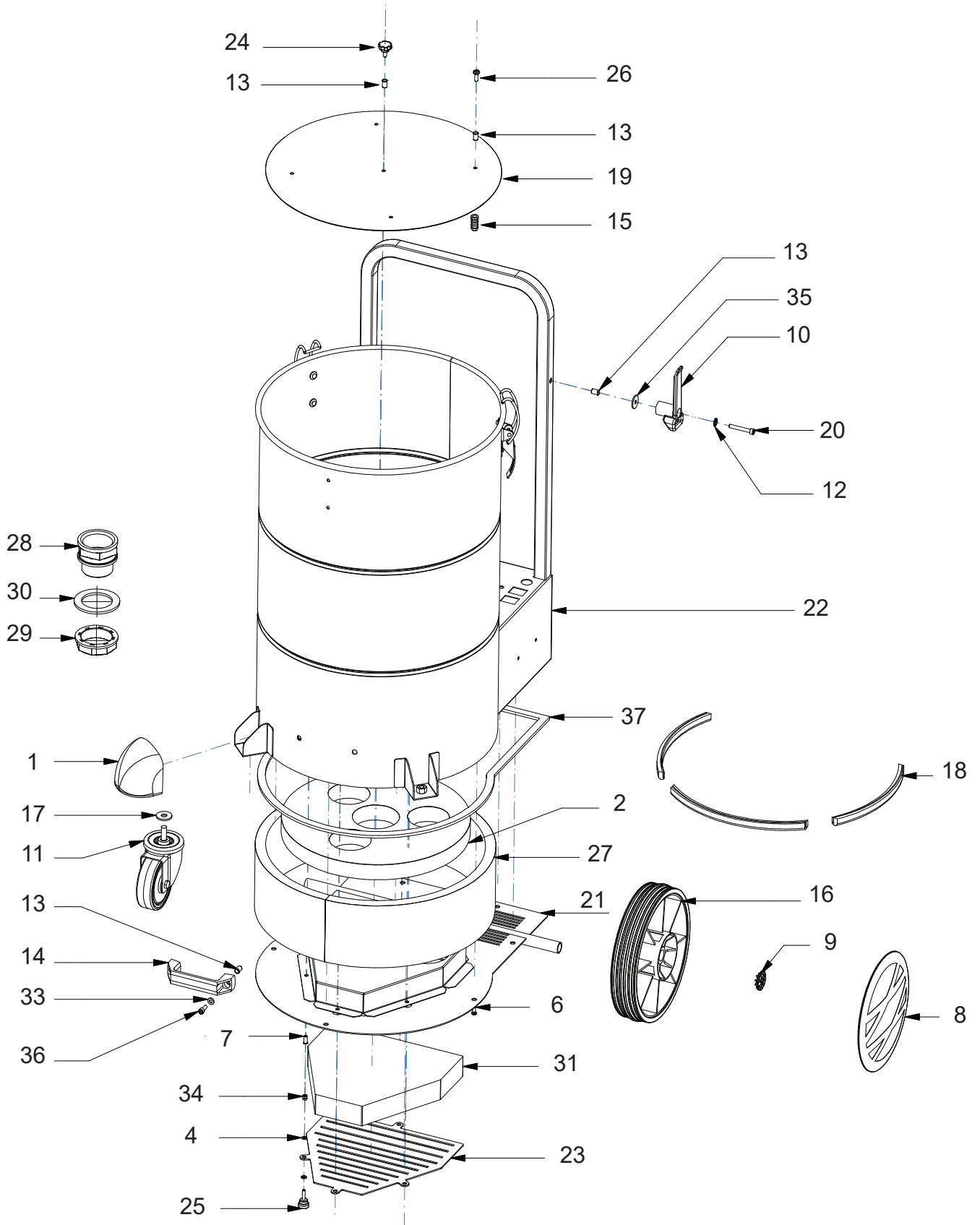

## Tank Assembly (continued)

<u>Item</u>	<u>Ref. No.</u>	<u>Description</u>	<u>Qty</u>
1	TMB417215	PROTECTION CAP	2
2	TMB417486	SOUND ABSORBENT COVER	1
3	TMB417505	HOOK	3
4	TMB417987	WASHER	21
5	TMB417986	WASHER	6
6	TMB408855	SCREW	7
7	TMB417609	INSERT	11
8	TMB417186	COVER	2
9	TMB418140	BUMPER RING D. 20MM	2
10	TMB416543	SUPPORT	1
11	TMB442309	PIVOTING WHEEL D.100 TBF/7 M10 x 25 RIV.	2
12	TMB417998	WASHER	1
13	TMB410545	INSERT	8
14	TMB225164	INCLINED BLACK HANDLE HOLES D.8.5	2
15	TMB437787	CAP	1
16	TMB418014	WHEEL	5
17	TMB409194	WASHER 11 x 30 x 2.5 UNI 6593	2
18	TMB417909	GASKET	2
19	TMB442311	GRID DISTANCE D.450	1
20	TMB408807	SCREW	1
21	TMB228927	BOTTOM MACHINE RAL 7037	1
22	TMB227705	TANK AVAC 18 RAL7037 CONDUCT.	1
23	TMB225315	FILTER GRID	1
24	TMB442375	KNOB	1
25	TMB445520	KNOB D.20 WITH PIN M5 x 20	4
26	TMB408860	SCREW	4
27	TMB442596	SOUND ABSORBENT SIDE FRAME	1
28	TMB441691	FITTING	1
29	TMB417516	RING NUT	1
30	TMB417555	GASKET	1
31	TMB445510	FOAM FILTER	1
32	TMB409360	RIVET	6
33	TMB409156	WASHER	2
34	TMB409080	LOCK NUT	4
35	TMB417996	WASHER	1
36	TMB408808	SCREW	2
37	TMB417541	FOAM LININGS H5 x 15	1

# Vacuum Motor Assembly

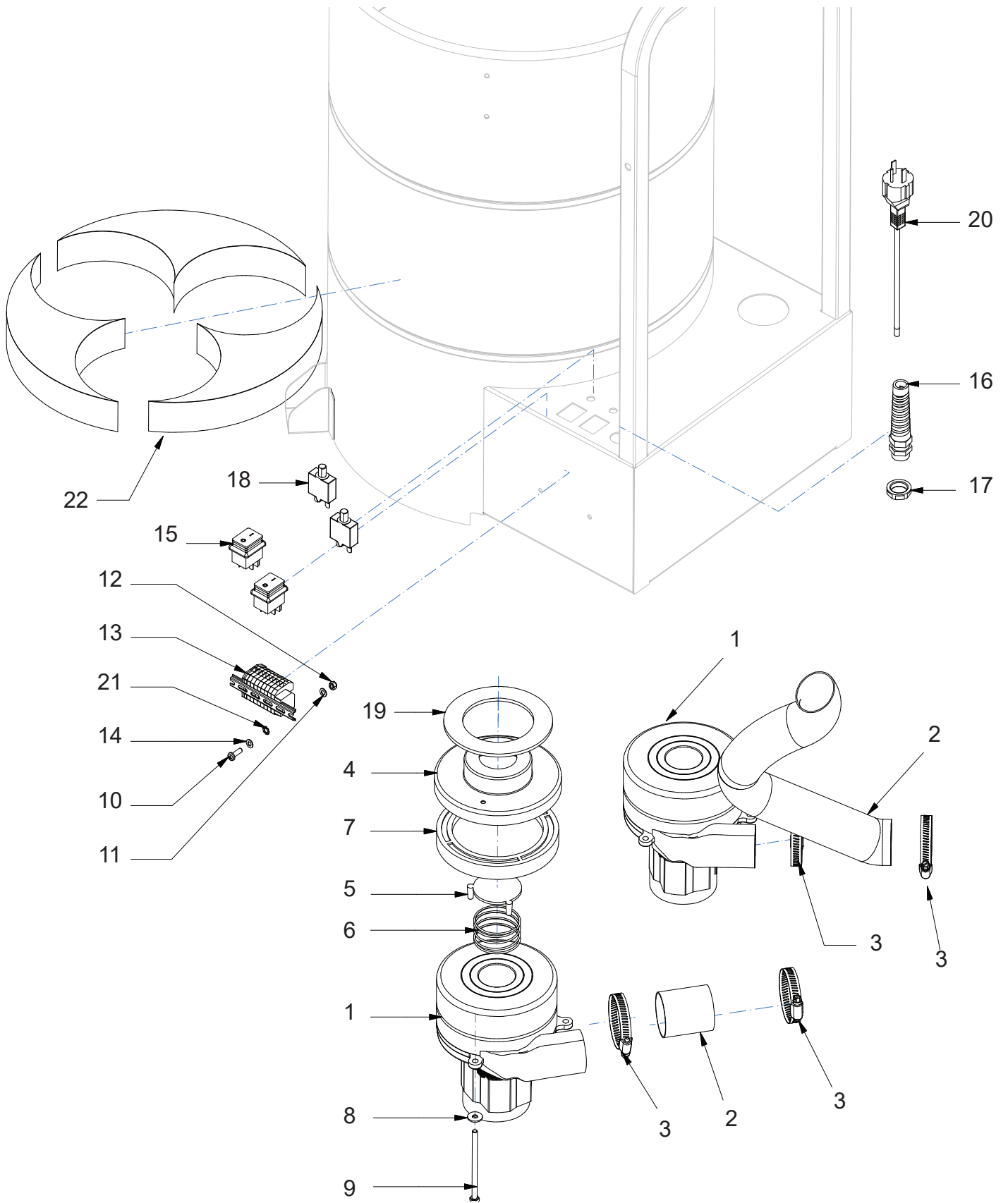



## Vacuum Motor Assembly (continued)

<u>Item</u>	<u>Ref. No.</u>	<u>Description</u>	<u>Qty</u>
1	TMB442058	ENGINE 120V-CL 1-800W-50Hz	2
2	TMB422492	TUBE 0.50 AL MT.	2
3	TMB410287	CLAMP	4
4	TMB417893	SUPPORT	2
5	TMB417893	VALVE	2
6	TMB417787	VALVE SPRING 0.56 x 1 STAINLESS	2
7	TMB417564	GASKET	6
8	TMB409160	WASHER	6
9	TMB422078	SCREW	2
10	TMB408854	SCREW	2
11	TMB409150	WASHER	2
12	TMB416781	LOCK NUT	1
13	TMB225373	8 TERMINAL ELEMENTS+ RAIL DIN	2
14	TMB417987	WASHER	2
15	TMB417622	BLACK BIPOLAR SWITCH	1
16	TMB417826	CABLE GUIDE	1
17	TMB417523	RING NUT	2
18	TMB409509	CIRCUIT BREAKER	2
19	TMB449893	GASKET FILTER ASP.CARPET	1
20	TMB447268	CABLE SJTW 3X14AWG 1050 GREY PLUG USA	1
21	TMB409334	WASHER	1
22	TMB417484	SOUND ABSORBENT BASE	1

# Limited Warranty

## AVAC18

### TO QUALIFY FOR THIS WARRANTY

- (1) Machine must be registered at the time of purchase on a form provided by American Sanders. Your American Sanders Distributor is responsible for the registration of your machine. Please cooperate with your Distributor in supplying necessary information on the card.
- (2) The machine must have been purchased from American Sanders or an authorized American Sanders Distributor.
- (3) This warranty extends to the original purchaser only and is not transferable to subsequent owners.

### TIME PERIODS

- (1) ONE (1) YEAR WARRANTY - For the AVAC18. Warranted to be free from defects in material and workmanship for a period of one (1) year from the date of purchase by the original owners. (See Exclusions)

### EXCLUSIONS (Not Covered by Warranty)

- (1) Parts that fail through normal wear by reason of their characteristics (cords, hoses, & etc.).
- (2) This warranty does not extend to parts affected by misuse, neglect, abuse or improper maintenance. All defective parts must be returned to the distributor for credit.

### THE OBLIGATION OF AMERICAN SANDERS

- (1) The obligation of American Sanders under this warranty is limited to repairing or replacing, at its option, any part which is proven to be defective in material or workmanship under normal use for the applicable period stated above.
- (2) Warranty repairs will be made by your American Sanders Distributor without charge for parts and labor. They will be compensated with a warranty labor rate of \$45.00 per hour, for the first year of ownership.
- (3) Parts repaired or replaced under this warranty are warranted only during the balance of the original warranty period. All defective parts replaced under these warranties become the property of American Sanders.

### WARRANTY SERVICE

To obtain warranty service, take your machine and proof of purchase to any authorized American Sanders Distributor. American Sanders will not reimburse expenses for service calls or travel. For the Distributor in your area, call American Sanders Customer Service Department at 800-367-3550 or 336-372-8080. If you are dissatisfied with the service that you receive, call or write American Sanders Customer Service Department for further assistance.

### INSTRUCTIONS AND CONDITIONS FOR WARRANTY REIMBURSEMENT

- Order replacement part: Orders will be processed and charged, as normal procedure.
- Call American Sanders for R/A number.
- You will need the Engine Serial Number, Machine Serial Number, and the Machine Model Number.
- Parts must be returned, accompanied with the R/A number to be eligible for warranty credit.
- All Warranty Parts will be shipped prepaid UPS Ground, any other method will be at the recipients expense.
- Freight on any Warranty Part after 30 days must be paid for by the Purchaser.
- Warranty labor rate is \$45.00 per hour.
- Credit will be issued upon completion of the above steps, at the above rates.

### DISCLAIMER OF CONSEQUENTIAL

AMERICAN SANDERS DISCLAIMS ANY RESPONSIBILITY FOR LOSS OF USER TIME OF THE AMERICAN SANDER MACHINE OR ANY OTHER INCIDENTAL OR CONSEQUENTIAL DAMAGE EXCEPT AS STATED IN THE WARRANTY APPLICABLE TO EACH MACHINE. EXCEPT AS STATED IN SUCH WARRANTIES, THE COMPANY DOES NOT OTHERWISE WARRANT ANY MACHINE AND NO WARRANTY, EXPRESS, IMPLIED OR STATUTORY IS MADE BY THE COMPANY.

© 2019 American Sanders





## **American Sanders**

an AMANO Company

1 Eclipse Rd ● PO Box 909  
Sparta, North Carolina 28675 ● USA  
[www.pioneereclipse.com](http://www.pioneereclipse.com)  
[www.americansanders.com](http://www.americansanders.com)

+1-336-372-8080  
1-800-367-3550  
Fax 1-336-372-2913